

MAPLEWOOD POLICE DEPARTMENT

CRIME PREVENTION DIVISION

Chief of Police
Robert Cimino



PREVENT BURGLARIES

HOW TO PROTECT YOUR HOME

Crime Prevention Unit 762-3400

Dear Resident,

WHAT IS CRIME PREVENTION?

“Crime Prevention is the anticipation, the recognition and the appraisal of a crime risk and the initiation of some action to remove or reduce it.”

One of the first areas in Crime Prevention that the Maplewood Police Department is working with is the Operation Identification Program. Several hundred cities have instituted this program and found it to be very successful. You can help in this fight against crime and protect your personal property by marking your valuable belongings with your Social Security Number. This will enable the police to readily identify stolen property and return the stolen property to the rightful owner.

The concept of this program is that stolen items from a home are seldom of value to the thief unless he can “fence” them. A “fence” does not like to handle items which are marked for ready identification. A thief caught with items which can be readily traced to the proper owner finds it difficult to avoid being arrested. For such reasons, thieves generally avoid homes marked as participating in this program. The Crime Prevention Division will supply each home with stickers for doors and windows.

It is also important that your home give the appearance of being occupied. When you leave your home during the hours of darkness, leave several interior lights on which will be visible to the outside. If you will be away on vacation, the lights should be regulated by timers. Make arrangements to have sidewalks shoveled in the winter and grass cut in the summer. Be sure to stop your mail and newspapers. A collection of newspapers and a stuffed mailbox make it obvious that the owners are away. When you leave your home, play a radio loud enough to be heard from the outside. Notify your neighbors when you leave on vacation, and leave a key with a neighbor who can check the house occasionally. If there is a break-in, they should notify the Police immediately.

A thief is going to choose an entry into a home that offers him the easiest entry and quickest exit, and least exposure to discovery. He will go through a window quicker than a door. He will usually pick a back door with glass, or a patio door, or try to come through the garage. This means you must not only adequately protect your doors through use of deadbolt locks, but also install adequate window locks. Do not economize on "cheapies." You should pay particular attention to the locks and latches on doors and windows located away from the street and in an area not readily visible to neighbors. If you have sliding doors, one way to prevent entry is to put a sawed-off broomstick into the inside channel of the track upon which the door slides. However, if the thief wants to enter badly enough, the sliding door offers him the best entrance. He may use a glass cutter to reach in and remove the stick. Special locks and latches can be placed on these doors in out-of-the-way places. If your garage has windows, put curtains over them; the same would apply for basement windows. Above all, do not leave cash in your home.

As Chief of Police, I pledge myself and the members of the Police Department to support Crime Prevention efforts. With mutual cooperation between the Police and residents, we can reduce crime.

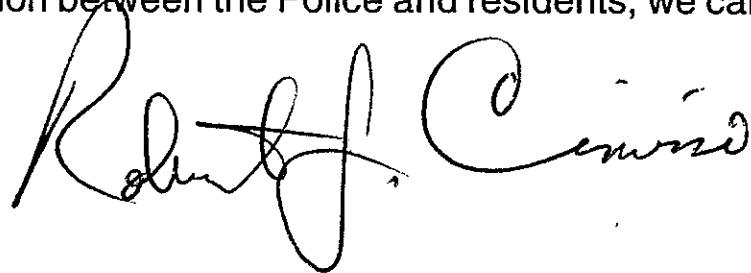
A handwritten signature in black ink, reading "Robert J. Curcio". The signature is written in a cursive style with a large, prominent initial "R".

The Crime Prevention Division of the Maplewood Police Department is offering the following services to the residents of Maplewood just by calling the Crime Prevention Division at 762-3400

OPERATION IDENTIFICATION

Electric engravers are available along with brochures and decals to permanently mark valuable items you own with your SOCIAL SECURITY NUMBER.

NEIGHBORHOOD WATCH

Upon request, a Crime Prevention Officer will come to a selected residential area (usually a one-block area) and organize the citizens living there to become more aware that residential Break and Entries is a problem and what steps they can take to remove the risk of being a target for a Break and Entry for themselves as well as their neighbors.

RESIDENTIAL BUILDING SURVEYS

Just by calling the Crime Prevention Division, a Crime Prevention Officer will come to your home and make a free survey and make his recommendations on what you can do to better secure your home.

FILMS AND SPEAKERS AVAILABLE

If your civic club, church, or neighborhood group will give us a call, a speaker from the Crime Prevention Division will be happy to come by and talk to you about your particular problem.

"NEIGHBORHOOD WATCH"

**HELP YOUR POLICE
PROTECT YOUR NEIGHBORHOOD**

**REPORT THE UNUSUAL
IMMEDIATELY**

WE CAN STOP HIM IF YOU HELP!!!

Report any unusual or suspicious persons, vehicles, or circumstances to the Maplewood Police Department — 762-3400.

HOW DOES "NEIGHBORHOOD WATCH" WORK?

"Neighborhood Watch" is a cooperative effort of the residents and Police to reduce crime in a neighborhood. It operates on the principle of neighbor helping neighbor by keeping an eye on each other's property and possessions and by reporting any suspicious activity to the Police.

IMPORTANT

"Neighborhood Watch" does not require that anyone take personal risks to prevent crime but does require its residents working side by side to make their neighborhood safer.

There are two phases to the program:

1. To make you aware of the many ways a home and property can be made safer, the Crime Prevention Division will show you various security devices and techniques that will make your home, possessions, and family less likely to be victimized by crime.
2. To make you "alert" to suspicious activity in the neighborhood.
 - a. Reporting suspicious looking persons (see Description Sheet).
 - b. Jotting down the license numbers of suspicious cars or trucks cruising the neighborhood.

Awareness and involvement are the key words to the success of "Neighborhood Watch." If all neighbors become involved, and you do your part, you can feel more secure knowing that your neighbors are also doing their part to protect your home and family.

Remember, crime is not only a Police problem, but a Community problem as well. With the citizens working with the Police we can, together, reduce crime.

DESCRIPTION SHEET

HAT

HAIR

BEARD - MOUSTACHE

SHIRT

COAT & COLOR

WEAPON

TROUSERS

SHOES

HEIGHT

WEIGHT

RACE

EYES - GLASSES

SCARS - TATTOOS - MARKS

AGE

CAR

LICENSE NUMBER



SELECTED SECURITY STEPS

DOUBLE LOCKING CYLINDER VS. SINGLE LOCKING CYLINDER FEATURE

If your lock is by a window or sidelight, you need:

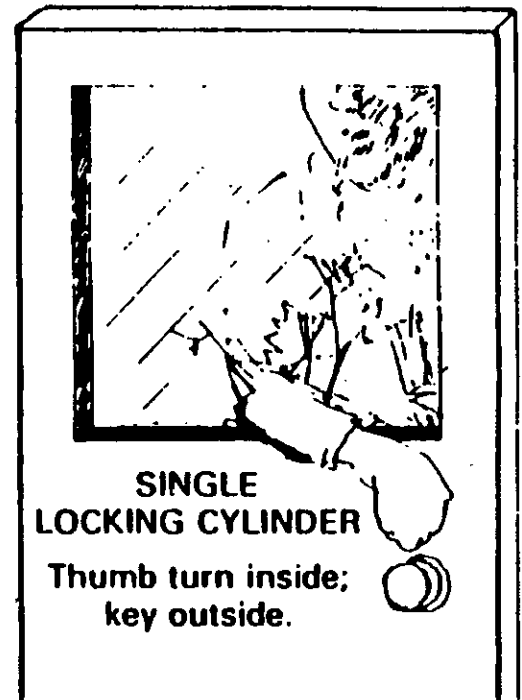
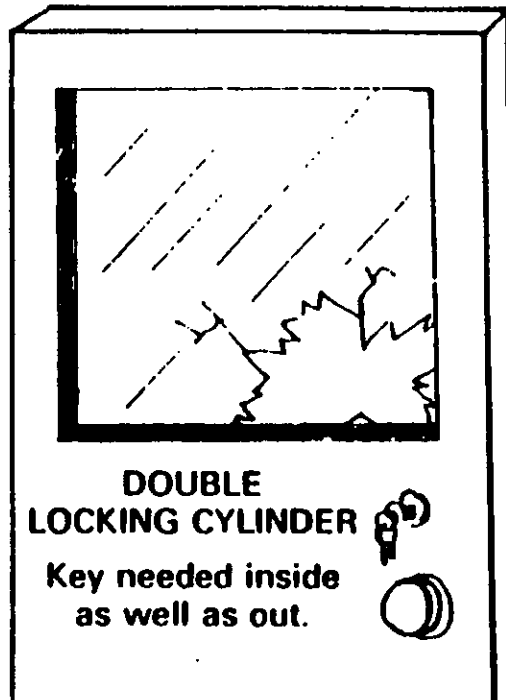

All window locks are vulnerable to this type of defeat. For this reason, keyed locks are recommended for most windows.

PRECAUTION ABOUT EXIT IN CASE OF FIRE

Double locking cylinder deadbolts present a potential hazard if a fire should occur. Keys to locks should be kept on hooks near the door, at night only, to provide easy access to all family members. All other times, keys should be taken with you. Fire drills are a good idea.

Peepholes, or interviewers, are recommended for all outside entrance doors.

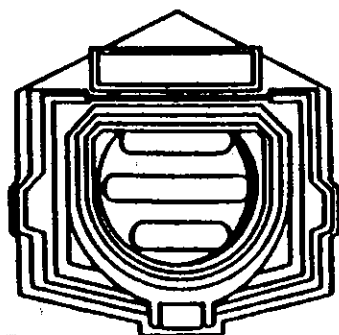

From Outside—
SHOWN CLOSED

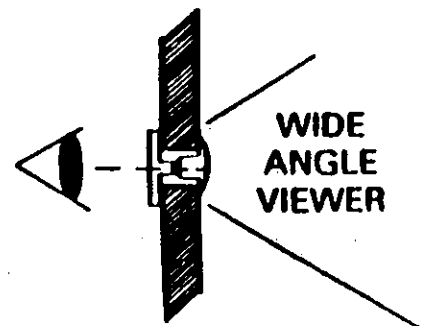

WIDE
ANGLE
VIEWER

LAMP CONNECTED TO
AUTOMATIC TIMER

BRIGHT PORCH
LIGHT

A CONSTANT LIGHT
IN BATHROOM



LEAVES RAKED

GRASS CUT

RECORD DESCRIPTION AND
SERIAL NUMBER OF POWER
MOWER, OUTBOARD MO-
TORS, AND OTHER TOOLS.

EXTERIOR
LIGHTING

DEVICE TO LIMIT
WINDOW OPENING

LIGHT OVER SIDE
AND REAR DOORS

BASEMENT WINDOWS
SECURED

ALL TOOLS,
INCLUDING LADDER,
STORED INSIDE

KEEP GARAGE
DOOR CLOSED
AND LOCKED

DESCRIPTION AND SERIAL
NUMBERS RECORDED

PORCH CLEAR OF
NEWSPAPERS, ETC.

SNOW CLEARED
MAILBOX EMPTY
REPLACE WITH SLOT
TYPE IN DOOR

CRIME PREVENTION DIVISION
MAPLEWOOD POLICE DEPARTMENT

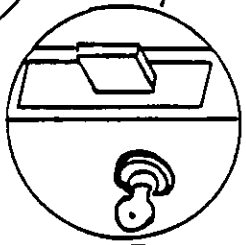

RECOMMENDED
TYPE LOCKS

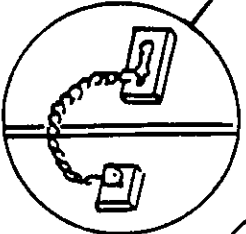

CHAIN DOOR GUARD
(NIGHT CHAIN)

ADDITIONAL DOOR SECURITY

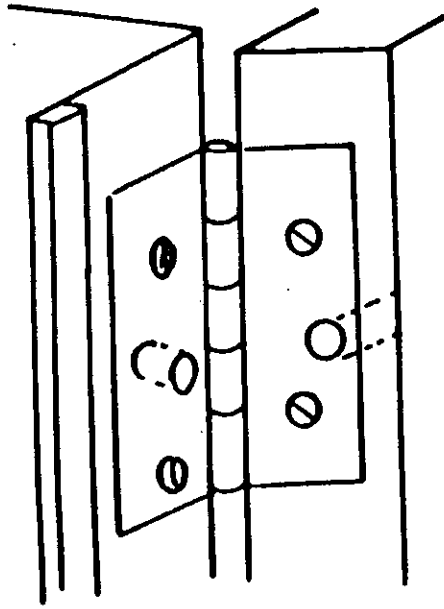

HINGES with pins removable from outside the door.

Replace one of the hinge screws with a nail and allow it to protrude into a matching hole when the door is closed. OR purchase a hinge with non-removable pins.

HARDENED SHACKLE PADLOCKS

Padlocks, to be effective, should have:

1. Both heel and toe locks.
2. A laminated or solid steel case.
3. Five-pin tumbler lock or equivalent pick-resistant locking cylinder.
4. Hardened shackle.

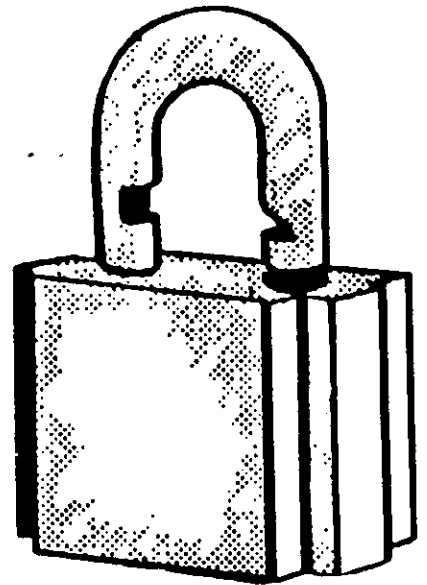

PADLOCKS ARE USED ON BICYCLES, MOTORCYCLES, GARAGE DOORS, SHEDS, AND ALL OUTBUILDINGS



HASPS

Hasps, to be effective, should:

1. Be as strong as the lock.
2. Have no screws or bolts visible when secured.
3. If installed on metal, use carriage bolts backed up with large washers to prevent prying the hasp off.

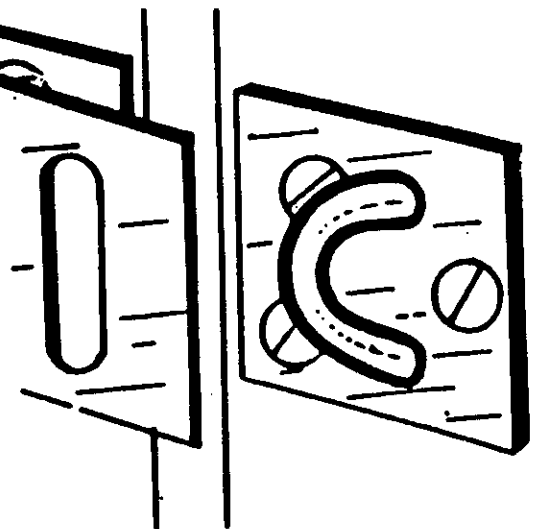

WINDOW LOCKS

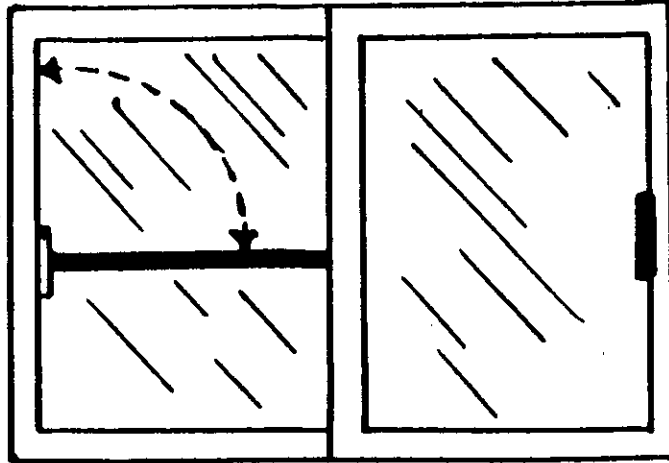

A STICK OR WOODEN DOWEL OR "CHARLIE BAR" may be used to add security to horizontal sliding windows.

HORIZONTAL SLIDING WINDOWS

Horizontal sliding windows may need to be secured from lifting out of tracks in the same fashion as patio doors.

Window may be PINNED and additional holes drilled for ventilation.

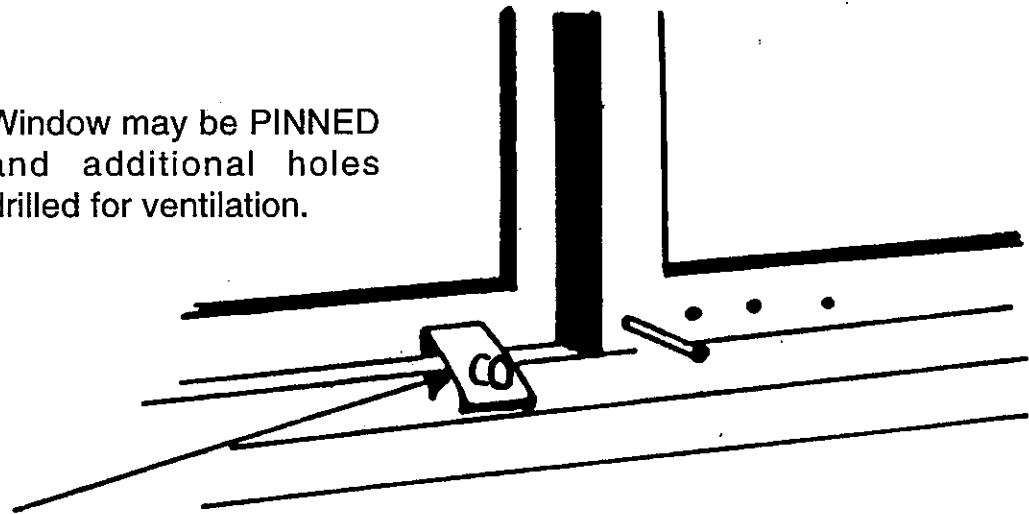

THUMB TURN, channel mounted locks are available for purchase.

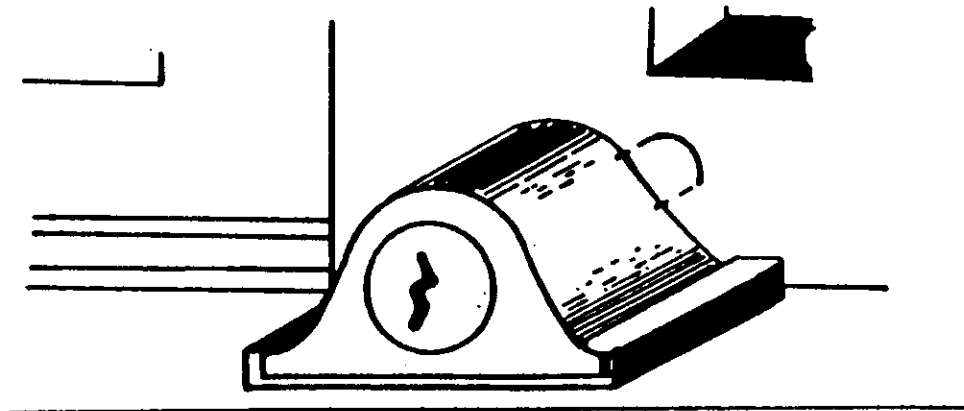

KEY operated locks may also be used.

DOUBLE HUNG WINDOWS

PINNING WINDOWS

Drill hole through first sash and into but not through the second sash. Additional holes may be drilled for ventilation.

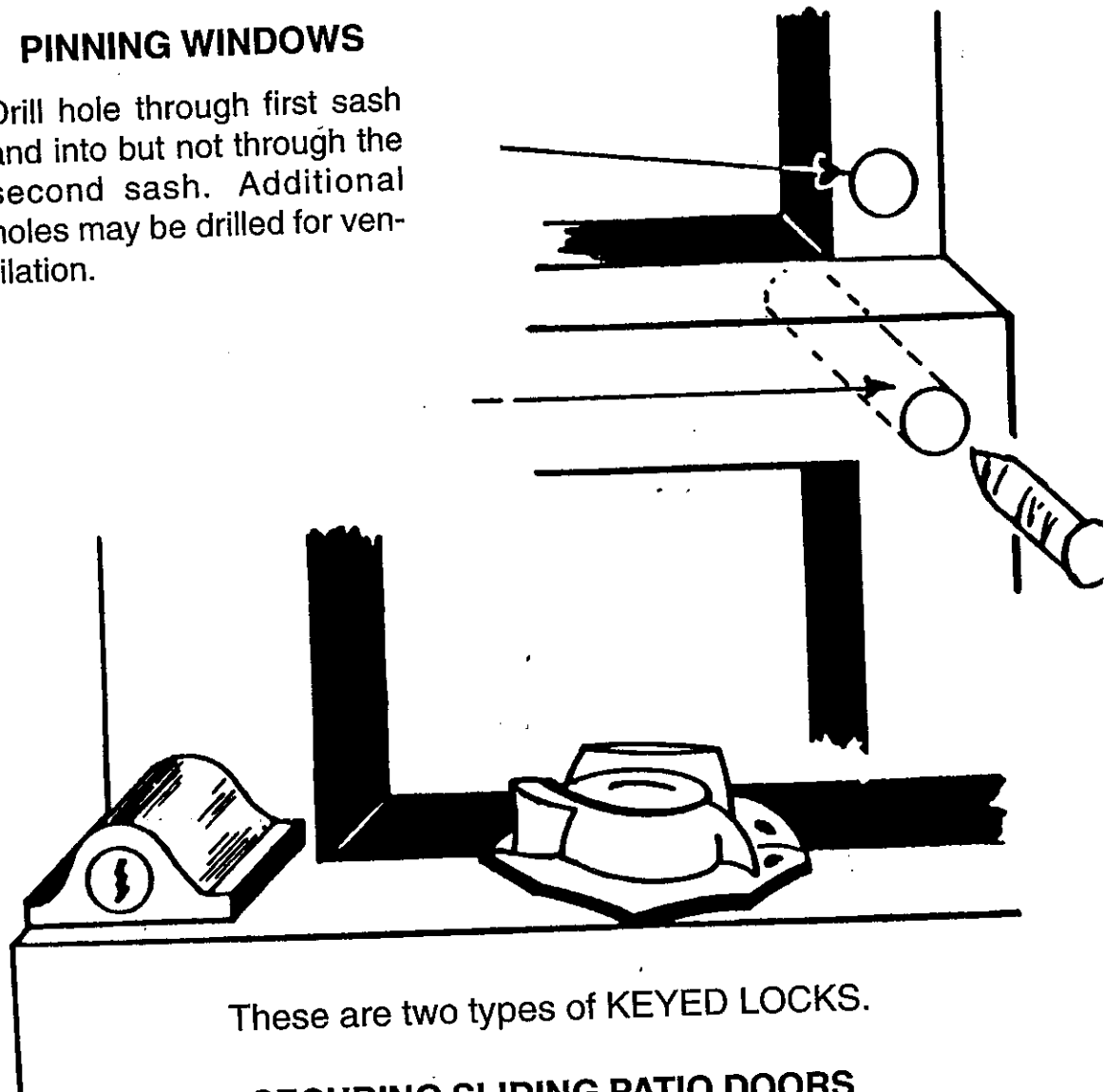

These are two types of KEYED LOCKS.

SECURING SLIDING PATIO DOORS

A commercial locking device is recommended for sliding doors.

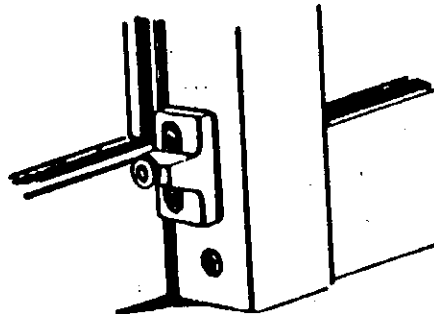

GLASS PATIO DOORS AND SLIDING DOORS can present a problem. Many devices, simple or elaborate, may be implemented to add security to this type of door. Any of the measures described below will help secure these doors.

TO PREVENT SLIDING DOOR FROM BEING LIFTED OUT OF THE TRACK, drill holes in the upper track and adjust machine screws so the door slides clear but cannot be lifted from the lower track. Shim plates can also be purchased and used for the same purpose.

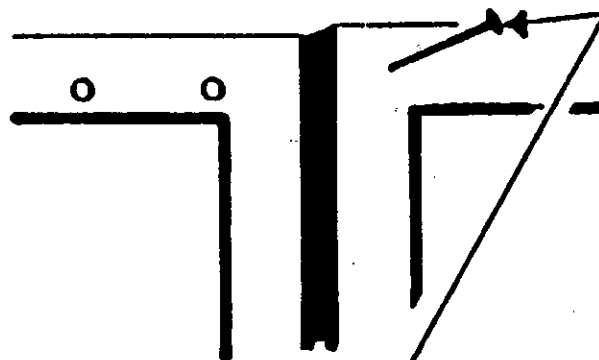
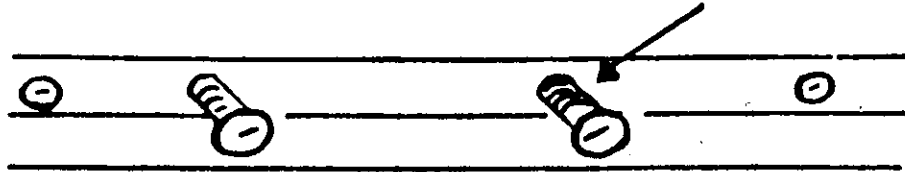

A **NAIL OR DOWEL** can be fit snug into matching holes in overlapping frames to prevent lifting and sliding.

ADDITIONAL HOLES may be drilled to provide locking in an open position for ventilation.

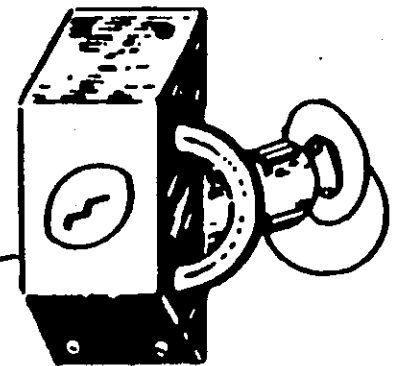
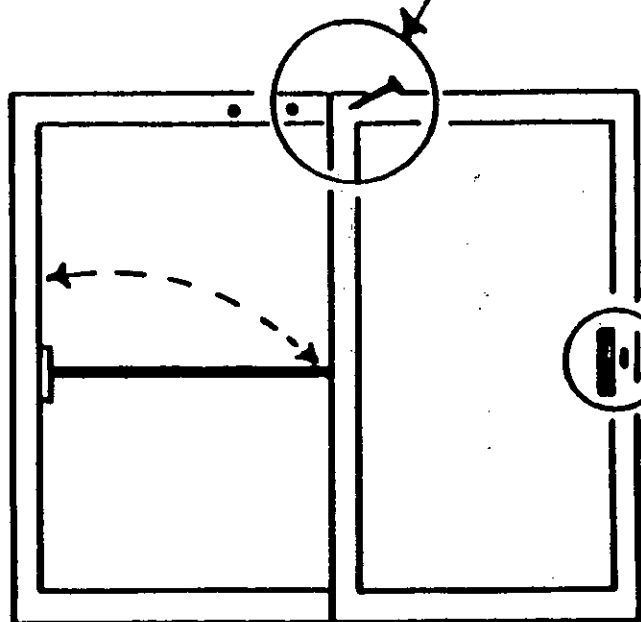

PATIO KEY LOCK

If **KEYED ENTRY** is desirable, this type of lock can be used.

A **HINGED BAR** can be purchased which will swing up out of the way or down to keep door from sliding. A **STICK OR DOWELING** can also be dropped into the door channel.

CASEMENT WINDOWS

Break-resistant glazing material is available for windows of all types.

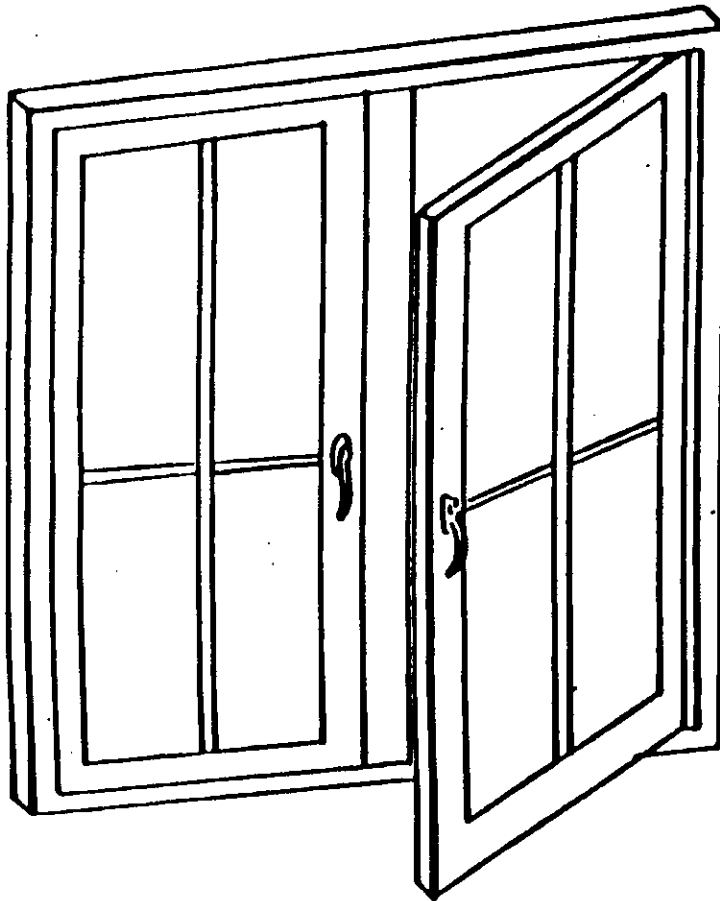

KEYED LOCKS are available for casement windows also.

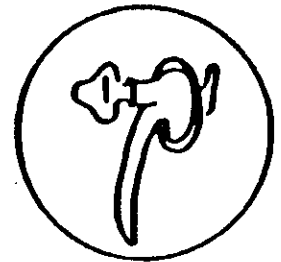

GRATES FOR BASEMENT WINDOWS

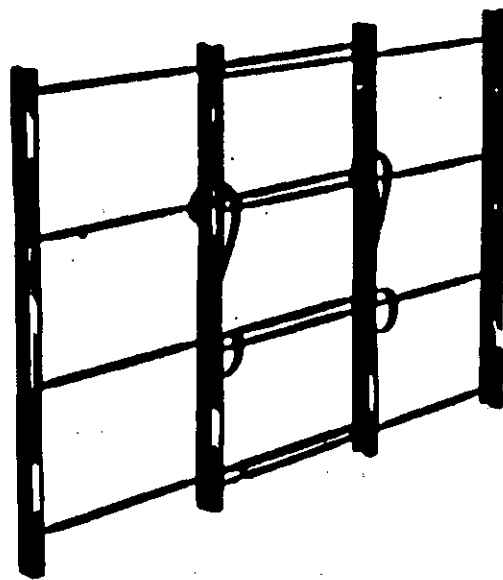

NOTE: Will prevent entry but is a potential fire hazard due to escape route being blocked.

REMEMBER — NEVER GIVE A BURGLAR AN EVEN BREAK

Walks and driveways should be kept free from offering concealment to intruders and other criminals.

Gates and fences. While offering possible concealment to criminals, gates and fences properly used can also deter the removal of large items and increase the difficulty of breaking in.

Alarms provide added protection and are most effective when used with other security techniques. Alarms are designed to detect an attempted intrusion. Your local law enforcement agency can provide proper advice with regard to alarms.

Mark all property. Check on proper procedures, maintain records of serial numbers of all valuables. This aids in the return of stolen property.

Prune large trees. Low limbs can provide second story access.

Lawn care. A very effective clue that someone is at home and cares.

Trim shrubs. Deny intruders a hiding place to work; don't block the view. Permit ready visibility by neighbors and Police.

Keep a watchful eye on your neighbor's home.

Report *immediately* to Maplewood Police any suspicious acts, persons, vehicles, or circumstances. Write down accurate descriptions or license numbers.

Discourage burglars by using proper locks, and being alert.

Remember, an informed, alert, and active community is absolutely necessary to win the war on crime.

Make Crime Prevention **CLICK**



Maplewood Police
Emergency Phone Number

Dial: 9-1-1

Business Phone: 762-3400